

P/N DDS-EWSxxD
Ref 91-0013

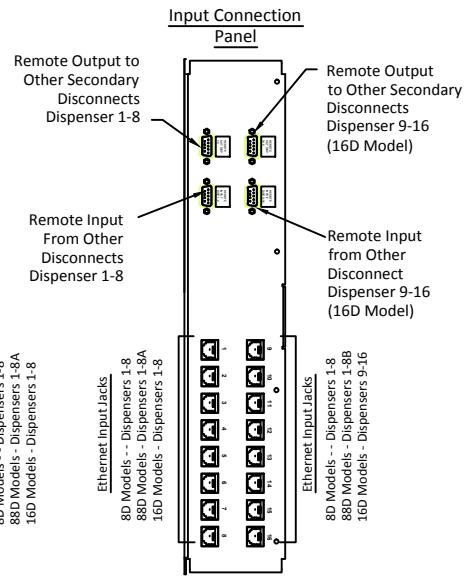

1 System Dimensions
SCALE NTS

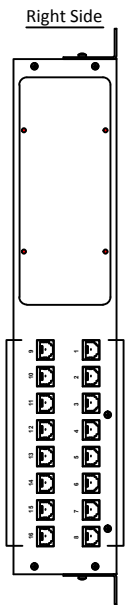
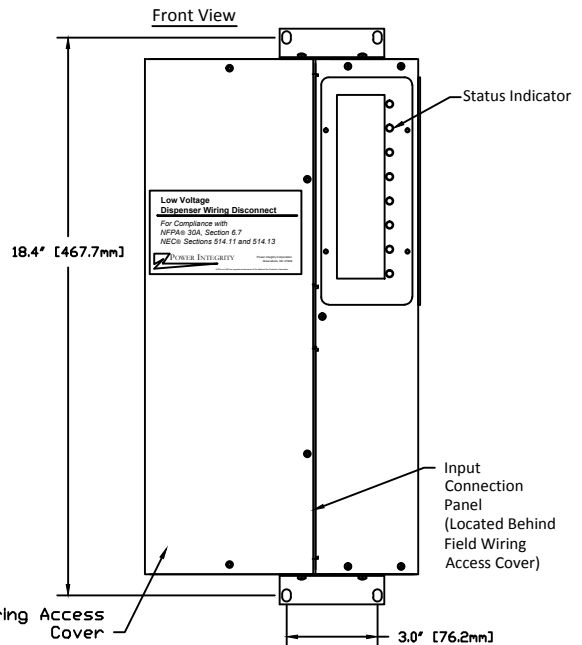
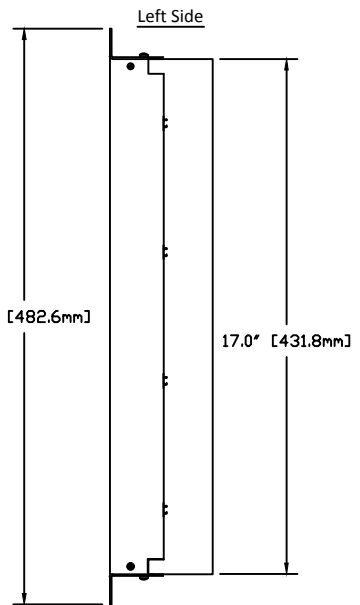
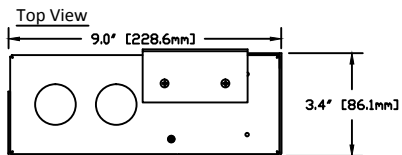
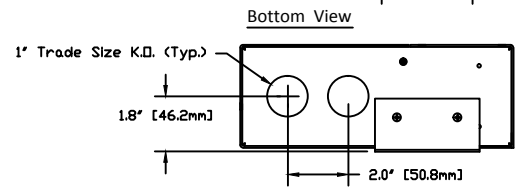

2 Model Numbers
SCALE NTS

Model	Description
DDS-EWS8D	Secondary Disconnect Wall Mount For Up to 8 Dispensers 1 Ethernet Circuit per Dispenser
DDS-EWS88D	Secondary Disconnect Wall Mount For Up to 8 Dispensers (2 Each) 1 Ethernet Circuit per Dispenser
DDS-EWS16D	Secondary Disconnect Wall Mount For Up to 16 Dispensers 1 Ethernet Circuit per Dispenser

REV	BY	DESCRIPTION	DATE
0	JF	New Release	10/13/2011
A	JA	Add Pages 2 & 3	07/02/2013
-	-	-	-
-	-	-	-
-	-	-	-
-	-	-	-

THIS DRAWING AND THE INFORMATION THEREIN IS CONFIDENTIAL AND THE PROPERTY OF POWER INTEGRITY CORP. THIS CONFIDENTIAL INFORMATION IS DISCLOSED TO YOU ON THE CONDITION THAT IT NOT BE DISCLOSED TO ANYONE OTHER THAN A POWER INTEGRITY EMPLOYEE AND NOT BE REPRODUCED IN WHOLE OR IN PART WITHOUT THE WRITTEN AUTHORIZATION OF POWER INTEGRITY CORPORATION.

TOLERANCES UNLESS OTHERWISE SPECIFIED
.XX=±.005
.XX=±.015
.X=±.03
FRACTIONS=± 1/64
DEGREES=±2'
DIMENSIONS IN INCHES

POWER INTEGRITY
Corporation
1834 PEMBROKE ROAD
GREENSBORO, N.C. 27408
PH: 336-379-9773
FAX: 336-379-1301
www.powerintegritycorp.com

DESCRIPTION: Dispenser Wiring Disconnect
EXTENDED DESC.:
Application Drawing for DDS-EWSxxD Secondary Disconnect for Ethernet to Dispenser (Wall Mount)
SCALE: N.T.S. DATE: 10/13/2011 SHEET: 1 of 3
P/N: DDS-EWSxxD REV. A

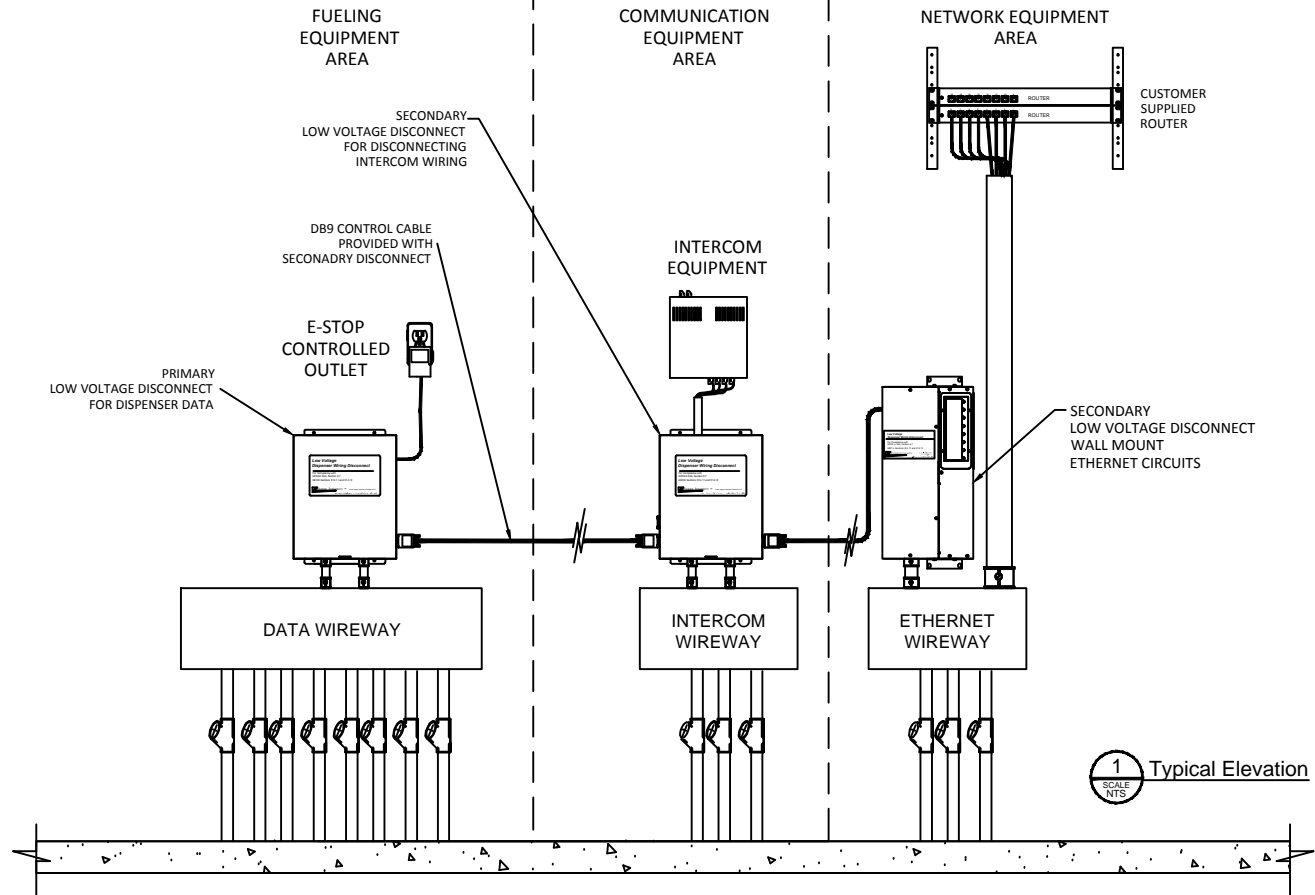

REV	BY	DESCRIPTION	DATE	<p>THIS DRAWING AND THE INFORMATION THEREIN IS CONFIDENTIAL AND THE PROPERTY OF POWER INTEGRITY CORP. THIS CONFIDENTIAL INFORMATION IS DISCLOSED TO YOU ON THE CONDITION THAT IT NOT BE DISCLOSED TO ANYONE OTHER THAN A POWER INTEGRITY EMPLOYEE AND NOT BE REPRODUCED IN WHOLE OR IN PART WITHOUT THE WRITTEN AUTHORIZATION OF POWER INTEGRITY CORPORATION.</p>	<p>TOLERANCES UNLESS OTHERWISE SPECIFIED .XX=±.005 .XX=±.015 .X=±.03 FRACTIONS=±1/64 DEGREES=±2' DIMENSIONS IN INCHES</p>	<p>POWER INTEGRITY Corporation 1834 PEMBROKE ROAD GREENSBORO, N.C. 27408 PH: 336-379-9773 FAX: 336-379-1301 www.powerintegritycorp.com</p>	DESCRIPTION: Dispenser Wiring Disconnect		
O	JF	New Release	10/13/2011				EXTENDED DESC.: Application Drawing for DDS-EWSxxD Secondary Disconnect for Ethernet to Dispenser (Wall Mount)		
A	JA	Add Pages 2 & 3	07/02/2013				SCALE: N.T.S. DATE: 10/13/2011 SHEET: 2 of 3		
-	-	-	-				P/N: DDS-EWSxxD REV. A		
-	-	-	-						
-	-	-	-						

SECONDARY
LOW VOLTAGE DISPENSER WIRING
DISCONNECT
 For Dispensers 1-8 CAT5
 Power Integrity Model: **DDS-EWS8D**

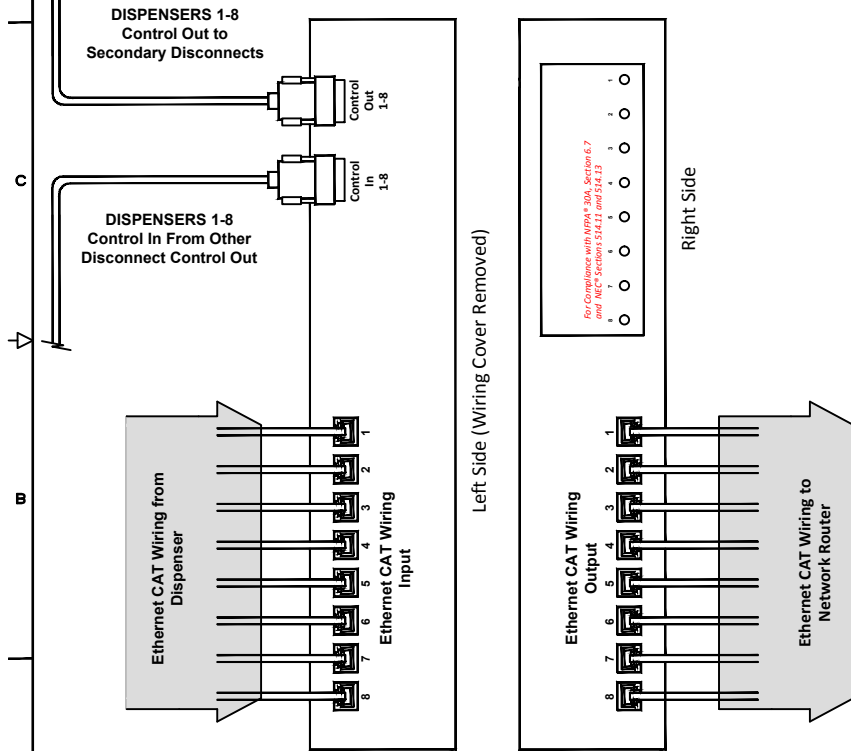

Secondary Low Voltage Disconnect - CAT5 Model: **(DDS-EWS8D)**

Install Equipment:

- Securely attach to the wall using appropriate fasteners.

Make Connections:

- Identify the wires connected to each dispenser or fueling positions.
- There is 1 Ethernet cable per dispenser.
- All Ethernet CAT wiring from a dispenser must be connected to the same channel of the Secondary Disconnect as controlled by the associated disconnect switch located in the primary disconnect. This can be verified by the response of the channel indicators to the operation of the disconnect switch in the primary disconnect.

Connect DB9 Control Cable:

- The Secondary Disconnects are powered and controlled by the Primary Disconnect by using a DB9 control cable.
- Connect the DB9 cable provide with the Secondary Disconnect to the Control Out connector of the Primary Disconnect or a previous Secondary Disconnect and the Control In connector of the Secondary Disconnect.

Step - 1: Connect the wiring from the dispenser to the DDS:

- Connect an Ethernet patch cable from the Dispenser #1 Port in the Patch Panel to the #1 position jack in the back of the Secondary Disconnect.

Step - 2: Connect the wiring from the DDS to the Network Router

- Connect an Ethernet patch cable from the #1 Position Jack on the front of the Secondary Disconnect to the network router.
- Repeat steps 1 and 2 listed above to connect the remaining fuel dispensers.

1
 SCALE
 N.T.S.
 Typical Wiring Connections

REV	BY	DESCRIPTION	DATE	THIS DRAWING AND THE INFORMATION THEREIN IS CONFIDENTIAL AND THE PROPERTY OF POWER INTEGRITY CORP. THIS CONFIDENTIAL INFORMATION IS DISCLOSED TO YOU ON THE CONDITION THAT IT NOT BE DISCLOSED TO ANYONE OTHER THAN A POWER INTEGRITY EMPLOYEE AND NOT BE REPRODUCED IN WHOLE OR IN PART WITHOUT THE WRITTEN AUTHORIZATION OF POWER INTEGRITY CORPORATION.		TOLERANCES UNLESS OTHERWISE SPECIFIED .XX=±.005 .XX=±.015 .X=±.03 FRACTIONS=± 1/64 DEGREES=±2° DIMENSIONS IN INCHES		 1834 PEMBROKE ROAD GREENSBORO, N.C. 27408 PH: 336-379-9773 FAX: 336-379-1301 www.powerintegritycorp.com		DESCRIPTION: Dispenser Wiring Disconnect EXTENDED DESC.: Application Drawing for DDS-EWSxxD Secondary Disconnect for Ethernet to Dispenser (Wall Mount) SCALE: N.T.S. DATE: 10/13/2011 SHEET: 3 of 3 P/N: DDS-EWSxxD REV. A		
0	JF	New Release	10/13/2011									
A	JA	Add Pages 2 & 3	07/02/2013									
-	-	-	-									
-	-	-	-									
-	-	-	-									
-	-	-	-									